

JTHS-600 Plus CNC High Speed Machine

Product descriptions and features

■ Features

- New generation CNC controller
- Temperature control technology, long-term accuracy is stable
- New structure design improves machine rigidity, stable and reliable

■ For Material

special copper, aerospace aluminum, high hardness steel, quenched material, etc

■ Applied Range

mold inserting part, accurate electrode, accurate component machining



KEJIE website



KEJIE wechat

Parameters

Item	Parameter
X/Y/Z travel	600/500/300mm
Work table dimension	680×500mm
Max load of worktable	300kg
Spindle power/Max spindle speed	7.8kW/26000rpm
Spindle interface/taper	HSK E40
Rapid traverse rate	15m/min
Cutting feed rate	10m/min
Positioning accuracy	0.003mm/300mm
Repeatability	0.002mm
Machine net weight	7000kg
Machine net dimension	2160 x 2270 x 2480 mm
Power supply	3-PH AC380V ±5% (50Hz)

Standard Accessories

- High speed CNC controller
- High speed spindle
- AC servo motor
- Precision ball screw and guide rail
- Automatic tool magazine
- Spindle cooling system
- Automatic tool setter
- High accuracy package (FAGOR Nano level grating scale/Precise level cutting fluid cooling/High-speed and high-accuracy machining mode)

Optional Accessories

- NC system (FAGOR 8060)
- 4-axis rotary table
- Oil mist collector
- Wireless probe

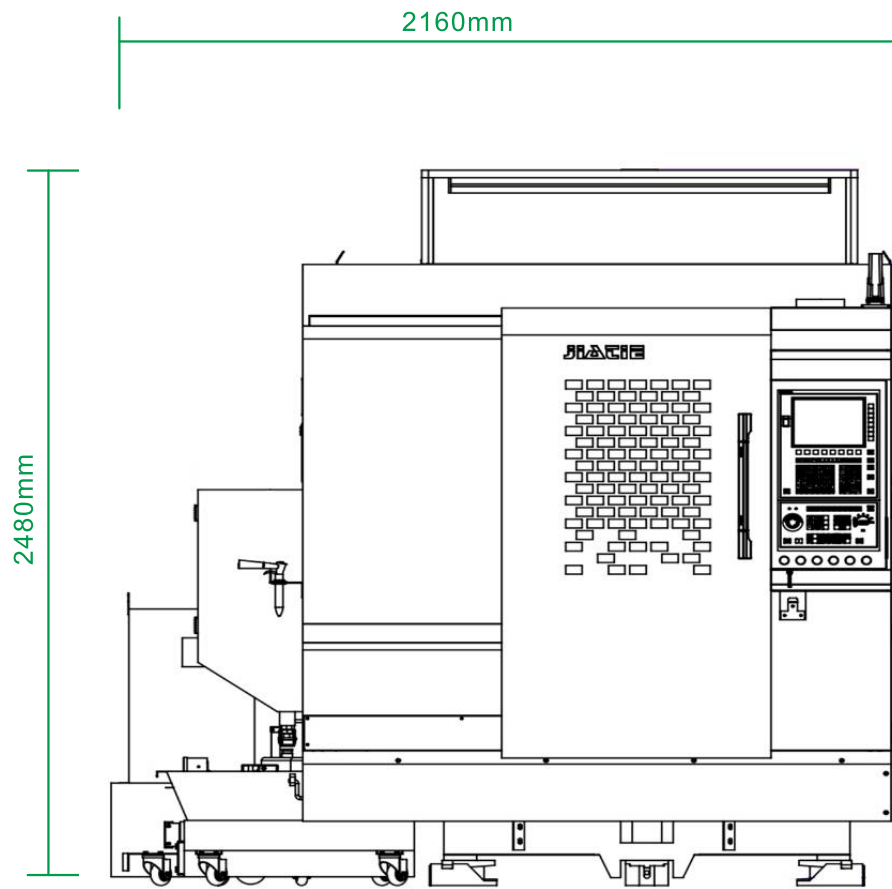

Front

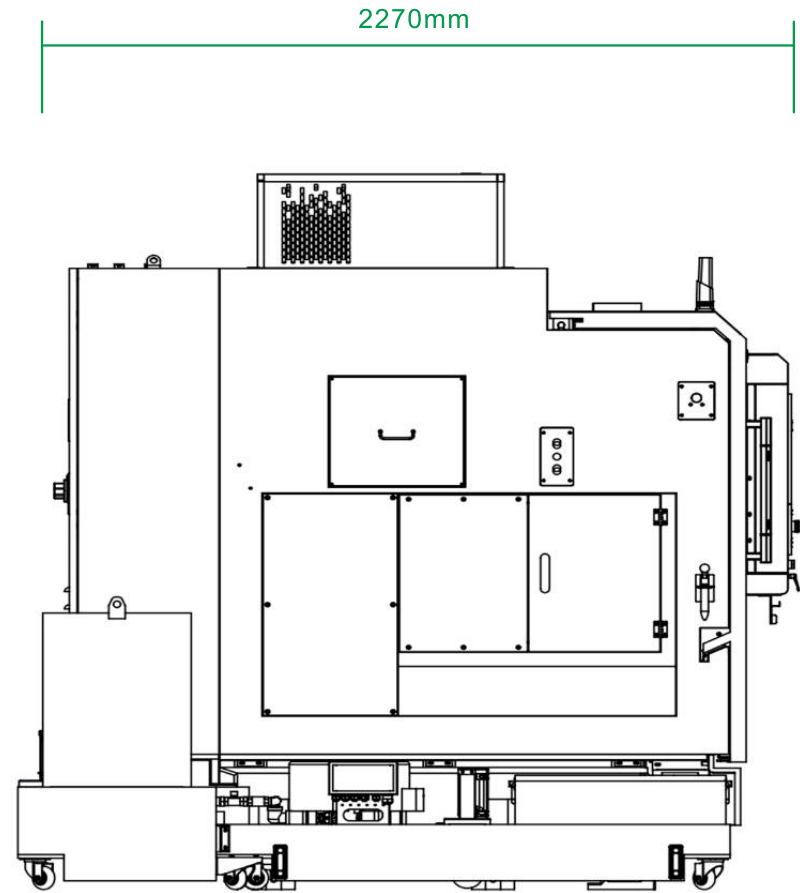

Left