



JTGK-500FS Graphite Machining Center

Product descriptions and features

■ Features

- Box type structure design and the unique damping characteristic have the machine more excellent dynamic machining performance.
- The axis movement system adopts special protective measures to increase the life of the moving parts.
- Multi-function optional, suitable for different demands of processing .

■ For Material

Graphite materials, ceramic green embryos, calcium silicate

■ Applied Range

High-end graphite electrode and parts processing



KEJIE website



KEJIE wechat

Parameters

Item	Parameter
X/Y/Z travel	500/400/250mm
Work table dimension	600 x400mm
Max load of worktable	300kg
Spindle power/Max spindle speed	7.2kW/32000rpm
Spindle interface/taper	HSK E40
Rapid traverse rate	X Y:15m/min Z:10m/min
Cutting feed rate	10m/min
Positioning accuracy	0.005mm/300mm
Repeatability	0.003mm
Machine net weight	5500kg
Machine net dimension	2100 x 2050 x 2500 mm
Power supply	3-PH AC380V ±5% (50Hz)

Standard Accessories

- High speed CNC controller
- High speed spindle
- AC servo motor
- Precision ball screw and guide rail
- Automatic tool setter
- Spindle cooling system
- Nano level grating scale
- Industrial dust collector

Optional Accessories

- Oil mist collector
- Voltage stabilizer
- 4-axis rotary table

Circular type tool magazine

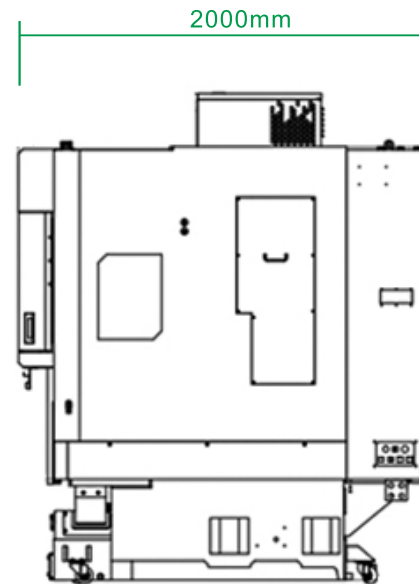
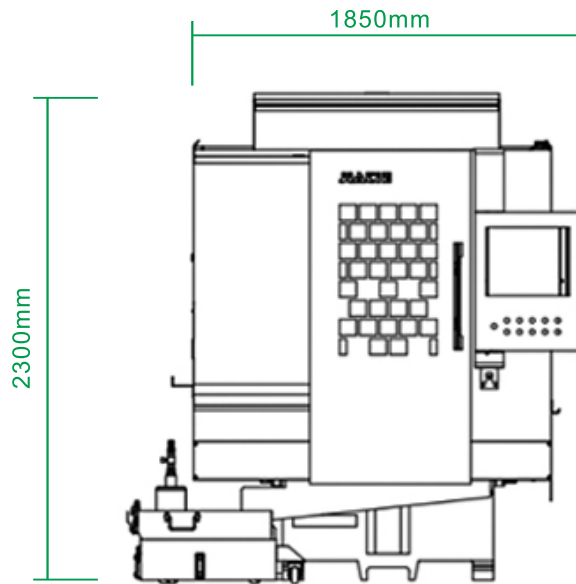

Chain type tool magazine

